

EMC TECHNICAL FILE

Product Name	:	Film Blowing Machine
Model Name	:	CX600-3500, CX-B-700~CX-B-4000, CX-50-700, CX-55-900, CX-60-1100, CX-65-1300, CX-70-1600, CX-75-1800, CX-85-2200, CX-90-2400, CX-ABA-700~CX-ABA-2800, CX-ABC-900~CX-ABC-4000, CX- AB-700~CX-AB-4000

Prepared for:

Zhejiang Chaoxin Machinery Technology Co., Ltd.
118 XINGLONG ROAD WANQUAN TOWN, PINGYANG COUNTY,
WENZHOU CITY, ZHEJIANG PROVINCE, CHINA

Prepared by:

Shanghai Global Testing Services Co., Ltd.
Floor 2nd, Building D-1, No. 128, Shenfu Road, Minhang District, Shanghai,
China.

TEL: +86-21-33637866

FAX: +86-21-33637858

File Number	:	TEZJ24061158907
Date of File	:	June 28,2024 to July 10,2024
Date of Issue	:	July 10,2024

Notes:

The Test results only relate to these samples which have been Tested.

Partly using this file will not be admitted unless been allowed by GTS.

GTS is only responsible for the complete file with the filed stamp of GTS.

Applicant:	Zhejiang Chaoxin Machinery Technology Co., Ltd.
	118 XINGLONG ROAD WANQUAN TOWN, PINGYANG COUNTY, WENZHOU CITY, ZHEJIANG PROVINCE, CHINA
Manufacturer:	Zhejiang Chaoxin Machinery Technology Co., Ltd.
	118 XINGLONG ROAD WANQUAN TOWN, PINGYANG COUNTY, WENZHOU CITY, ZHEJIANG PROVINCE, CHINA
Product Name:	Film Blowing Machine
Brand Name:	/
Model Name:	CX600-3500, CX-B-700~CX-B-4000, CX-50-700, CX-55-900, CX-60-1100, CX-65-1300, CX-70-1600, CX-75-1800, CX-85-2200, CX-90-2400, CX-ABA-700~CX-ABA-2800, CX-ABC-900~CX-ABC-4000, CX-AB-700~CX- AB-4000
Rating:	220V
Power Supply:	220V
Date of Receipt:	June 28,2024
Date of Test:	June 28,2024 to July 10,2024
Test Standard:	EN IEC 61000-6-2:2019, EN IEC 61000-6-4:2019, EN IEC 61000-3-2:2019+A1:2021, EN 61000-3-3:2013+A1:2019+A2:2021

Prepared by :



Approved by :



Table of contents

1.General Information	4
2.Techniacd Summary	5
3.Test Equipment List	6
4. Emission Test Results	8
5. Immunity Test Results	14
6. Harmonic Current Emission Test	23
7. Voltage Fluctuations And Flicker Test	25
PHOTO DOCUMENTATION:	27

1. General Information

1.1 Description of EUT

Product Name:	Film Blowing Machine
Model Name:	CX600-3500
Serial Number:	N/A
Power Supply:	220V
Applicant:	Zhejiang Chaoxin Machinery Technology Co., Ltd. 118 XINGLONG ROAD WANQUAN TOWN, PINGYANG COUNTY, WENZHOU CITY, ZHEJIANG PROVINCE, CHINA
Manufacturer:	Zhejiang Chaoxin Machinery Technology Co., Ltd. 118 XINGLONG ROAD WANQUAN TOWN, PINGYANG COUNTY, WENZHOU CITY, ZHEJIANG PROVINCE, CHINA

1.2 Description of Test Facility

Site Description:	Shanghai Global Testing Services Co., Ltd.
Name of Firm:	Shanghai Global Testing Services Co., Ltd.
Site Location:	Floor 2nd, Building D-1, No. 128, Shenfu Road, Minhang District, Shanghai, China.
The site and apparatus are constructed in conformance with the requirements of ANSI C63.4, CISPR 16-1-1 and other equivalent standards	

1.3 Measurement Uncertainty

No.	Item	Measurement Uncertainty
1	Conducted Emission at mains port using AMN	2.6dB (9kHz to 150kHz)
		2.4dB (150kHz to 30MHz)
2	Conducted Emission at mains port using VP	1.8 dB (9kHz to 30MHz)
3	Conducted Emission at telecommunication port using AAN	4.2 dB (150kHz to 30MHz)
4	Radiated Power	3.2dB
5	Radiated Emission	4.5dB (30MHz-1GHz)
		5.1dB (1GHz-6GHz)
		5.4dB (6GHz-18GHz)
6	Radiated Disturbance (disturbance current in a LLAS)	2.4dB (9kHz to 30MHz)

Note: The measurement uncertainty represents an expanded uncertainty expressed at approximately the 95% confidence level using a coverage factor of k=2.

2. Technical Summary

Emission Part				
Item	Standard	Method	Requirement	Result
Conducted Emissions at Mains Terminals (150kHz-30MHz)	EN IEC 61000-6-4:2019	CISPR 16-2-1	N/A	Pass
Radiated Emissions (30MHz-1GHz)	EN IEC 61000-6-4:2019	CISPR 16-2-3	N/A	Pass
Immunity Part				
Item	Standard	Method	Requirement	Result
Electrostatic Discharge	EN IEC 61000-6-2:2019	EN 61000-4-2:2009	4kV Contact Discharge 8kV Air Discharge	Pass
Radiated Immunity(80MHz-6GHz)	EN IEC 61000-6-2:2019	EN IEC 61000-4-3:2020	10V/m, 80%, 1kHz Amp. Mod. 3V/m, 80%, 1kHz Amp. Mod.	Pass
Electrical Fast Transients/Burst at Power Port	EN IEC 61000-6-2:2019	EN 61000-4-4:2012	2kV 5/50ns Tr/Td 5kHz Repetition Frequency	Pass
Surge at Power Port	EN IEC 61000-6-2:2019	EN 61000-4-5:2014+A1:2017	1.2/50µs Tr/Td 1kV Line to Line 2kV Line to Ground	Pass
Conducted Immunity at Power Port (150kHz-80MHz)	EN IEC 61000-6-2:2019	EN IEC 61000-4-6:2023	10Vrms (emf),80%,1kHz Amp. Mod.	Pass
Power-frequency Magnetic Field Immunity	EN IEC 61000-6-2:2019	EN 61000-4-8:2010	50, 60Hz 30A/m	Pass
Voltage Dips	EN IEC 61000-6-2:2019	EN IEC 61000-4-11:2020	100% reduction, 1 cycle	Pass
Voltage Dips	EN IEC 61000-6-2:2019		60% reduction, 10 cycles	Pass
Voltage Dips	EN IEC 61000-6-2:2019		30% reduction, 25 cycles	Pass
Voltage Interruptions:	EN IEC 61000-6-2:2019		100% reduction, 250 periods	Pass

N/A: Not applicable

3.Test Equipment List

Conducted Emissions					
Equipment	Manufacturer	Model No	Inventory No	Cal Date	Cal Due Date
EMI Test Receiver	Rohde & Schwarz	ESCS30	SHEM015-1	2023-02-20	2025-02-19
EMI Test Receiver	Rohde & Schwarz	ESR7	SHEM162-1	2023-02-20	2025-02-19
Pulse limiter	Rohde & Schwarz	ESH3-Z2	SHEM029-1	2023-02-20	2025-02-19
Passive Voltage probe	Rohde & Schwarz	ESH2-Z3	SHEM028-1	2023-02-20	2025-02-19
Line impedance stabilization network	SCHWARZBECK	NSLK8127	SHEM061-1	2023-02-20	2025-02-19
Line impedance stabilization network	EMCO	3816	SHEM019-1	2023-02-20	2025-02-19

Radiated Emissions					
Equipment	Manufacturer	Model No	Inventory No	Cal Date	Cal Due Date
EMI Test Receiver	Rohde & Schwarz	ESCS30	SHEM015-1	2023-02-20	2025-02-19
EMI Test Receiver	Rohde & Schwarz	ESR7	SHEM162-1	2023-02-20	2025-02-19
Ultra-Broadband Antenna	Rohde & Schwarz	HL562	SHEM010-1	2023-02-20	2025-02-19
Biconical VHF-UHF broadband antenna	SCHWARZBECK	VUBA 9117	SHEM008-1	2023-02-20	2025-02-19
Active Loop Antenna	SCHWARZBECK	FMZB1519	SHEM135-1	2023-02-20	2025-02-19
Broadband UHF-VHF ANTENNA	SCHWARZBECK	VULB9168	SHEM048-1	2023-02-20	2025-02-19
Horn Antenna	Rohde & Schwarz	HF906	SHEM009-2	2023-02-20	2025-02-19
Pre-Amplifier	Agilent	8447D	SHEM143-1	2023-02-20	2025-02-19
Pre-Amplifier	Rohde & Schwarz	AFS42-001800-25-S-42	SHEM009-3	2023-02-20	2025-02-19

Electrostatic Discharge					
Equipment	Manufacturer	Model No	Inventory No	Cal Date	Cal Due Date
ESD Simulator	KIKUSUI	KES4021S	SHEM041-1	2023-02-20	2025-02-19
Electrostatic discharge simulator	3CTEST	EDS20H	SHEM199-1	2023-02-20	2025-02-19
Electrostatic discharge simulator	TESEQ	NSG 437	SHEM041-2	2023-02-20	2025-02-19

Radiated Immunity					
Equipment	Manufacturer	Model No	Inventory No	Cal Date	Cal Due Date
Signal Generator	Rohde & Schwarz	SMB 100A	SHEM194-1	2023-02-20	2025-02-19
Power Meter	Rohde & Schwarz	NRP	SHEM057-1	2023-02-20	2025-02-19
Sensor of power meter	Rohde & Schwarz	NRP-Z91	SHEM057-2	2023-02-20	2025-02-19
Power meter sensor	Rohde & Schwarz	NRP-Z22	SHEM136-1	2023-02-20	2025-02-19
Biconical VHF-UHF broadband antenna	SCHWARZBECK	VUBA 9117	SHEM008-1	2023-02-20	2025-02-19
Ultra-Broadband Antenna	Rohde & Schwarz	HL562	SHEM010-1	2023-02-20	2025-02-19
Power Amplifier	AR	30W1000B	SHEM059-1	2023-02-20	2025-02-19
Power Amplifier	MILMEGA	80RF1000-250	SHEM132-1	2023-02-20	2025-02-19
Power Amplifier	MILMEGA	AS0840-55-55	SHEM133-1	2023-02-20	2025-02-19
RF Power amplifier	Rohde & Schwarz	BBA150-E60	SHEM171-1	2023-02-20	2025-02-19

Electrical Fast Transients/Burst					
Equipment	Manufacturer	Model No	Inventory No	Cal Date	Cal Due Date
Immunity Test System	EMC PARTNER	TRA3000 F-S-D-V	SHEM163-1	2023-02-20	2025-02-19
EFT & Surge Generator	PRIMA	PRM61045TB	SHEM200-1	2023-02-20	2025-02-19
CDN for EFT & Surge	PRIMA	PRM-CDN	SHEM200-2	2023-02-20	2025-02-19
Capacitive coupling clamp	PRIMA	EFT-CLAMP	SHEM200-4	2023-02-20	2025-02-19

Surge					
Equipment	Manufacturer	Model No	Inventory No	Cal Date	Cal Due Date
Immunity Test System	EMC PARTNER	TRA3000 F-S-D-V	SHEM163-1	2023-02-20	2025-02-19
EFT & Surge Generator	PRIMA	PRM61045TB	SHEM200-1	2023-02-20	2025-02-19
CDN for EFT & Surge	PRIMA	PRM-CDN	SHEM200-2	2023-02-20	2025-02-19

Conducted Immunity					
Equipment	Manufacturer	Model No	Inventory No	Cal Date	Cal Due Date
Signal Generator	Rohde & Schwarz	SMB 100A	SHEM194-1	2023-02-20	2025-02-19
Power Amplifier	HAEFELY	PAMP250	SHEM023-1	2023-02-20	2025-02-19
Power Meter	Rohde & Schwarz	NRP	SHEM057-1	2023-02-20	2025-02-19
Sensor of power meter	Rohde & Schwarz	NRP-Z91	SHEM057-2	2023-02-20	2025-02-19
Power meter sensor	Rohde & Schwarz	NRP-Z22	SHEM136-1	2023-02-20	2025-02-19
Electromagnetic Clamp	EM Test	EM-101	SHEM027-1	2023-02-20	2025-02-19
Current probe	Eaton	91197-1L	SHEM147-1	2023-02-20	2025-02-19
Current Injection Probe	TESEQ	CIP 9136A	SHEM-A039	2021-12-31	2025-02-19

General used equipment					
Equipment	Manufacturer	Model No	Inventory No	Cal Date	Cal Due Date
Digital Multimeter	FLUKE	17B	SHEM043-3	2023-02-20	2025-02-19
Multi-purpose tong tester	FLUKE	316	SHEM001-1	2023-02-20	2025-02-19
e3 software	AUDIX	E3	N/A	N/A	N/A

4. Emission Test Results

4.1 Conducted Emissions At Mains Terminals (150KHZ-30MHZ)

Test Requirement: EN IEC 61000-6-4:2019
Test Method: CISPR 16-2-1
Frequency Range: 150kHz to 30MHz
Limit:
0.15M-0.5MHz 79dB(μV) quasi-peak, 66dB(μV) average
0.5M-30MHz 73dB(μV) quasi-peak, 60dB(μV) average
Detector: Peak for pre-scan (9kHz resolution bandwidth) 0.15M to 30MHz

4.1.1 E.U.T. Operation

Operating Environment:
Temperature: 25°C Humidity: 50% Rh Atmospheric Pressure: 1010Mbar
Test mode :Normal Working_keep EUT normal running continua

4.1.2 Test Setup Diagram

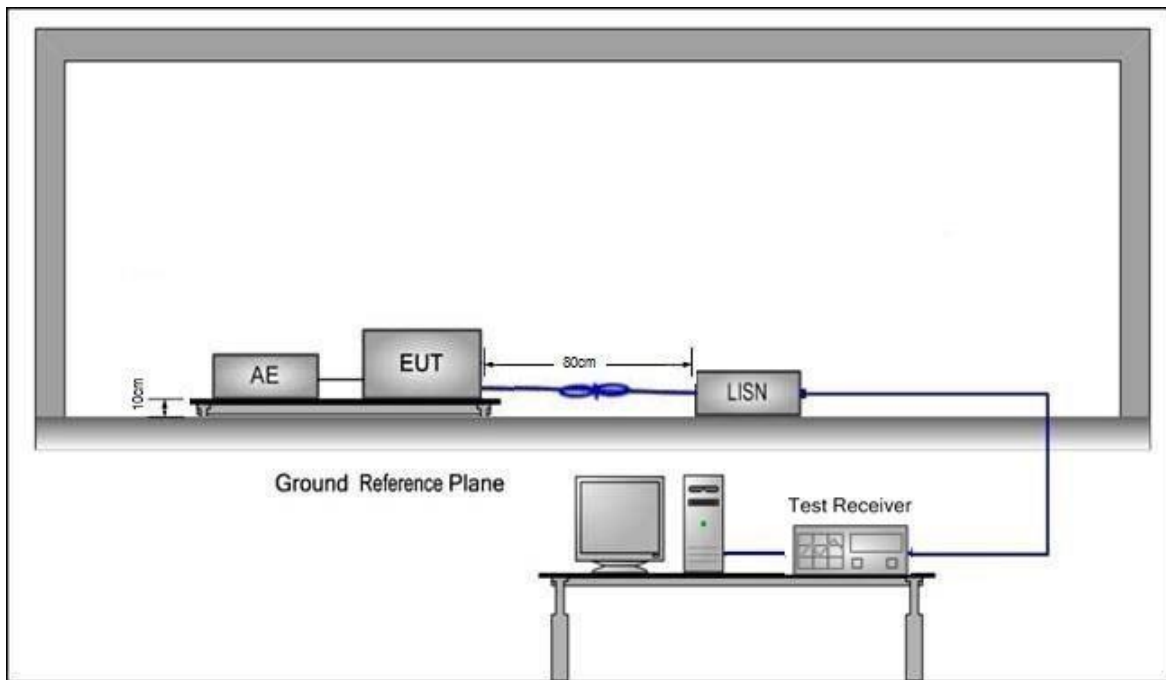

4.1.3 Measurement Data

An Initial Pre-Scan Was Performed With Peak Detector. Quasi-Peak Or Average Measurement Were Performed At The Frequencies With Maximized Peak Emission Were Detected.

Notes: Emission Level=Read Level + Vp Factor + Cable Loss

L1

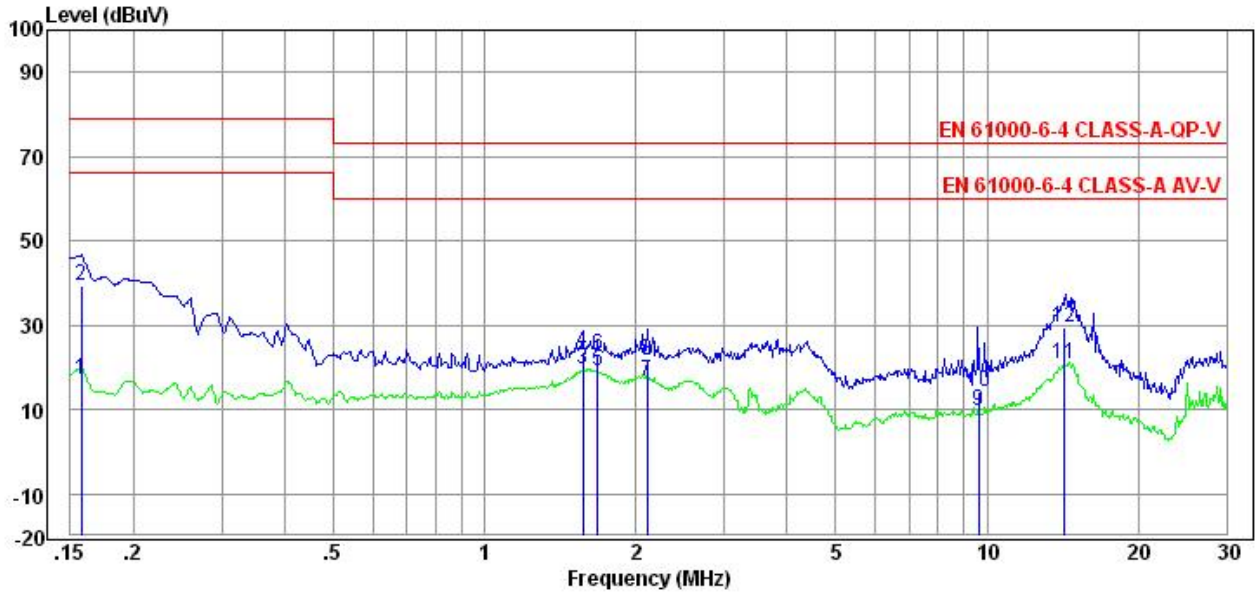

Freq MHz	Reading dBuV	C.F dB	Result dBuV	Limit dBuV	Margin dB	Detector
0.16	7.36	9.62	16.98	66.00	49.02	Average
0.16	29.97	9.62	39.59	79.00	39.41	QP
1.57	10.02	9.73	19.75	60.00	40.25	Average
1.57	13.98	9.73	23.71	73.00	49.29	QP
1.68	9.39	9.75	19.14	60.00	40.86	Average
1.68	13.03	9.75	22.78	73.00	50.22	QP
2.11	6.78	9.81	16.59	60.00	43.41	Average
2.11	11.83	9.81	21.64	73.00	51.36	QP
9.62	-0.24	10.07	9.83	60.00	50.17	Average
9.62	4.04	10.07	14.11	73.00	58.89	QP
14.30	10.84	10.03	20.87	60.00	39.13	Average
14.30	19.36	10.03	29.39	73.00	43.61	QP

N

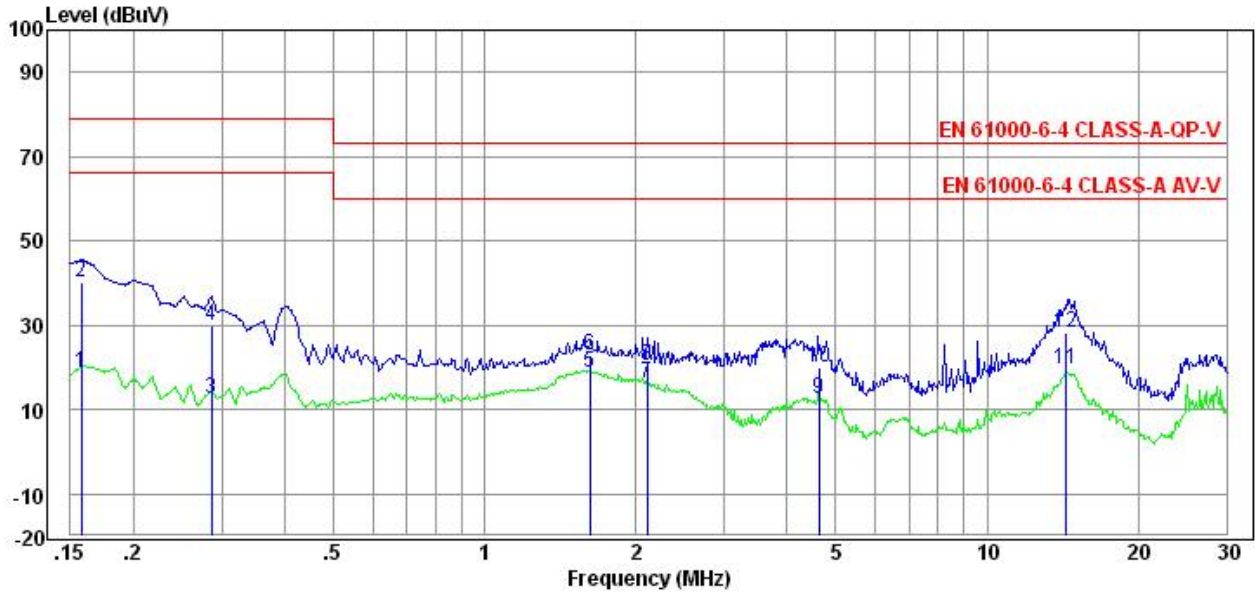

Freq MHz	Reading dBuV	C.F dB	Result dBuV	Limit dBuV	Margin dB	Detector
0.16	9.14	9.63	18.77	66.00	47.23	Average
0.16	30.59	9.63	40.22	79.00	38.78	QP
0.29	2.72	9.66	12.38	66.00	53.62	Average
0.29	20.06	9.66	29.72	79.00	49.28	QP
1.62	9.14	9.75	18.89	60.00	41.11	Average
1.62	13.16	9.75	22.91	73.00	50.09	QP
2.11	6.26	9.82	16.08	60.00	43.92	Average
2.11	10.49	9.82	20.31	73.00	52.69	QP
4.64	2.56	9.90	12.46	60.00	47.54	Average
4.64	10.18	9.90	20.08	73.00	52.92	QP
14.41	9.57	10.04	19.61	60.00	40.39	Average
14.41	18.38	10.04	28.42	73.00	44.58	QP

4.2 Radiated Emissions (30MHZ-1GHZ)

Test Requirement: EN IEC 61000-6-4:2019

Test Method: CISPR 16-2-3

Frequency Range: 30MHz to 1GHz

Limit:

30MHz-1GHz 50 dB(μ V/m) quasi-peak

Detector: Peak for pre-scan (120kHz resolution bandwidth) 30M to 1000MHz

4.2.1 E.U.T. Operation

Operating Environment:

Temperature: 25°C Humidity: 50% Rh Atmospheric Pressure: 1002 Mbar

Test mode :Normal Working_keep EUT normal running continua

4.2.2 Test Setup Diagram

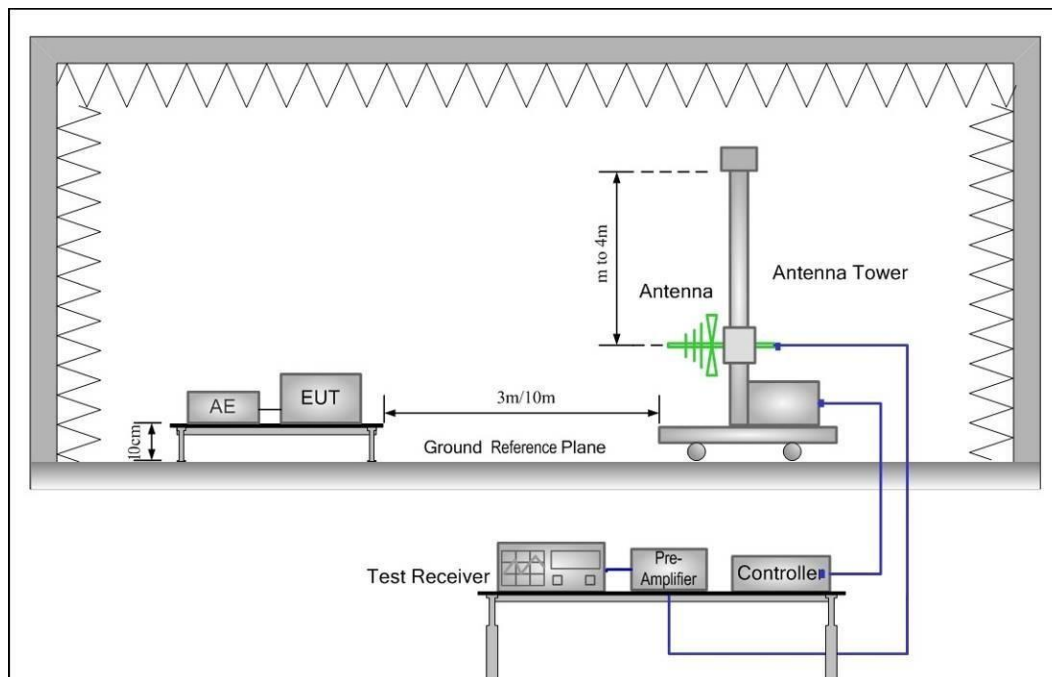

4.2.3 Measurement Data

An initial pre-scan was performed in the chamber using the spectrum analyser in peak detection mode. Quasi-peak measurements were conducted based on the peak sweep graph. The EUT was measured by BiConiLog antenna with 2 orthogonal polarities.

Polarization:Horizontal

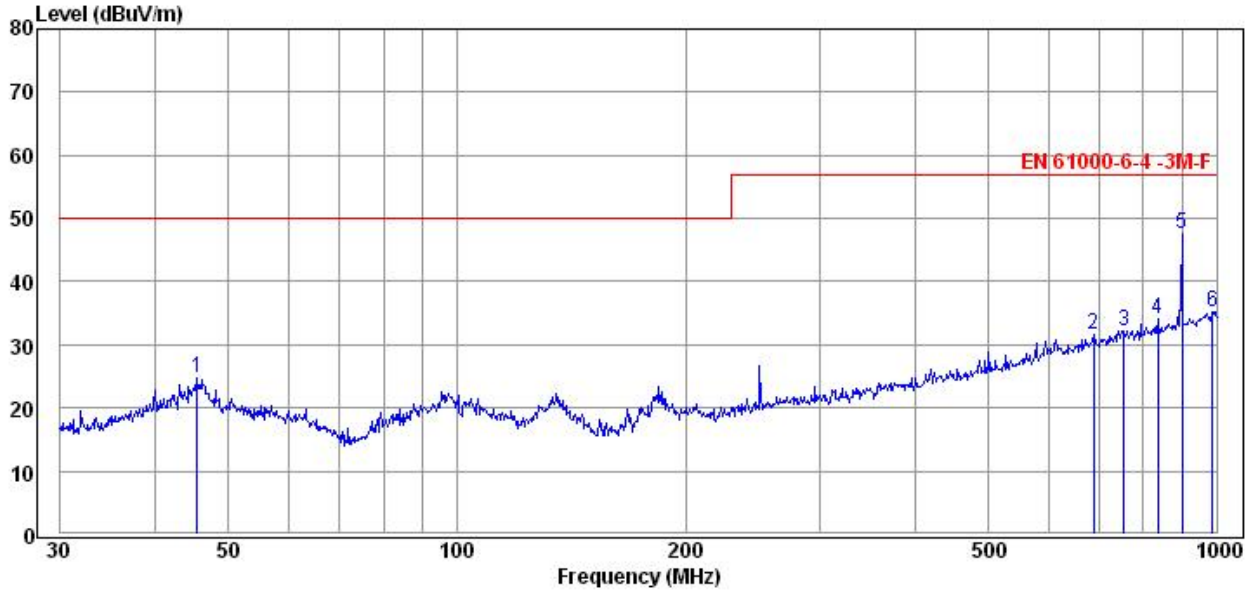

Freq MHz	Reading dBuV	C.F dB	Result dBuV	Limit dBuV	Margin dB	Detector
45.42	8.71	15.91	24.62	50.00	25.38	QP
688.65	6.91	24.66	31.57	57.00	25.43	QP
753.97	6.39	25.90	32.29	57.00	24.71	QP
837.08	7.19	26.96	34.15	57.00	22.85	QP
900.65	19.67	27.97	47.64	57.00	9.36	QP
986.08	6.49	28.83	35.32	57.00	21.68	QP

Remarks: C.F (Correction Factor) = Antenna factor + Cable loss - Preamp gain

Polarization:Vertical

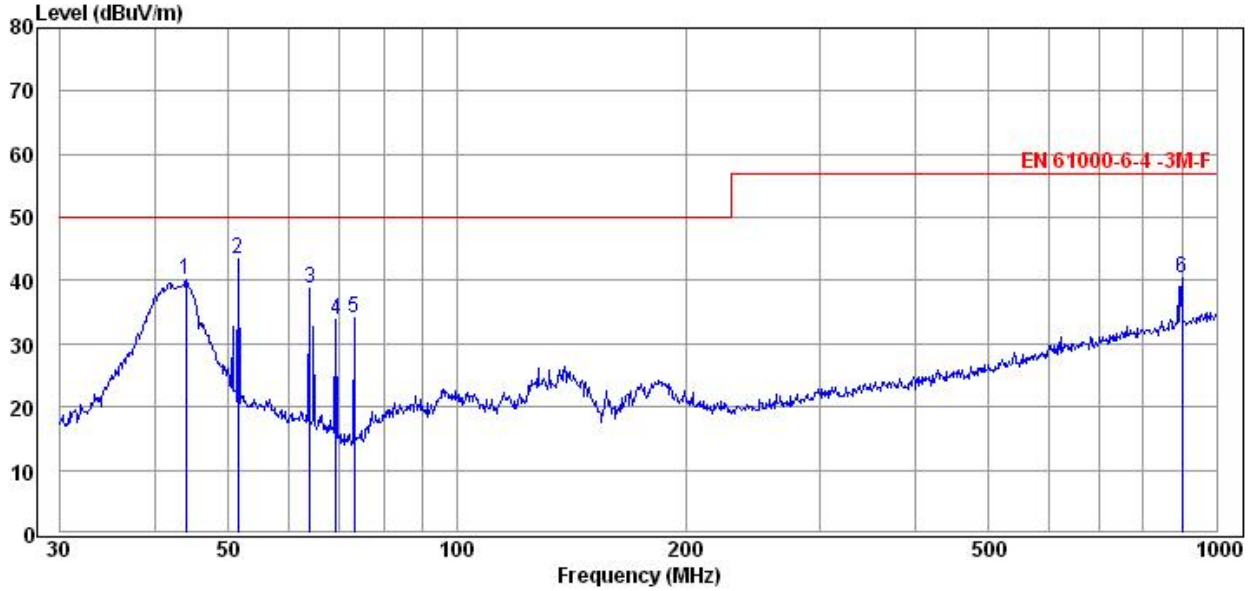

Freq MHz	Reading dBuV	C.F dB	Result dBuV	Limit dBuV	Margin dB	Detector
43.95	24.42	15.78	40.20	50.00	9.80	QP
51.39	27.50	15.92	43.42	50.00	6.58	QP
63.95	24.70	14.11	38.81	50.00	11.19	QP
69.26	21.95	11.93	33.88	50.00	16.12	QP
73.22	23.66	10.51	34.17	50.00	15.83	QP
900.91	12.51	27.97	40.48	57.00	16.52	QP

Remarks: C.F (Correction Factor) = Antenna factor + Cable loss - Preamp gain

5. Immunity Test Results

5.1 Performance Criteria Description In EN IEC 61000-6-2:2019

- Criterion A:** The apparatus shall continue to operate as intended during and after the test. No degradation of performance or loss of function is allowed below a performance level specified by the manufacturer, when the apparatus is used as intended. The performance level may be replaced by a permissible loss of performance. If the minimum performance level or the permissible performance loss is not specified by the manufacturer, either of these may be derived from the product description and documentation and what the user may reasonably expect from the apparatus if used as intended.
- Criterion B:** The apparatus shall continue to operate as intended after the test. No degradation of performance or loss of function is allowed below a performance level specified by the manufacturer, when the apparatus is used as intended. The performance level may be replaced by a permissible loss of performance. During the test, degradation of performance is however allowed. No change of actual operating state or stored data is allowed. If the minimum performance level or the permissible performance loss is not specified by the manufacturer, either of these may be derived from the product description and documentation and what the user may reasonably expect from the apparatus if used as intended.
- Criterion C:** Temporary loss of function is allowed, provided the function is self-recoverable or can be restored by the operation of the controls.

5.2 Electrostatic Discharge

Test Requirement: EN IEC 61000-6-2:2019
 Test Method: EN 61000-4-2:2009
 Performance Criterion: B
 Discharge Impedance: 330Ω/150pF
 Number of Discharge: Minimum 10 times at each test point
 Discharge Mode: Single Discharge
 Discharge Period: 1 second minimum

5.2.1 Test Setup Diagram

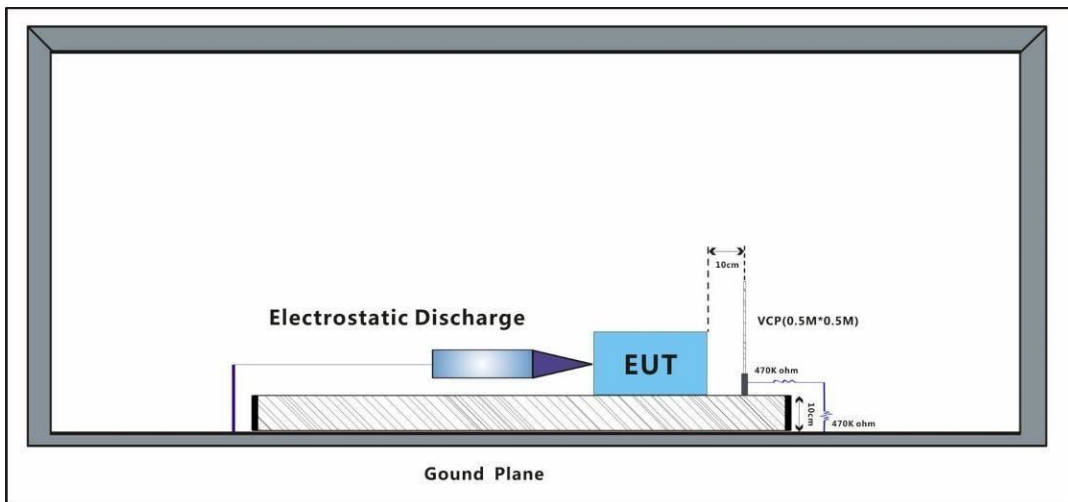

5.2.2 E.U.T. Operation

Operating Environment:
 Temperature: 25°C Humidity: 51% Rh Atmospheric Pressure: 1020Mbar
 Test mode :Normal Working_keep EUT normal running continua

5.2.3 Test Results:

Observations: Test Point:
 1. All insulated enclosure and seams.
 2. All accessible metal parts of the enclosure
 3. All side

Discharge type	Level (kV)	Polarity	Test Point	Result / Observations
Air Discharge	8	+	1	A
Air Discharge	8	-	1	A
Contact Discharge	4	+	2	A
Contact Discharge	4	-	2	A
Vertical Coupling	4	+	3	A
Vertical Coupling	4	-	3	A

Results:

A: No degradation in the performance of the EUT was observed.

5.3 Radiated Immunity(80MHz-6GHz)

Test Requirement: EN IEC 61000-6-2:2019
 Test Method: EN IEC 61000-4-3:2020
 Performance Criterion: A
 Frequency Range: 80MHz to 1GHz
 Antenna Polarisation: Vertical and Horizontal
 Modulation: 1kHz,80% Amp. Mod,1% increment

5.3.1 Test Setup Diagram

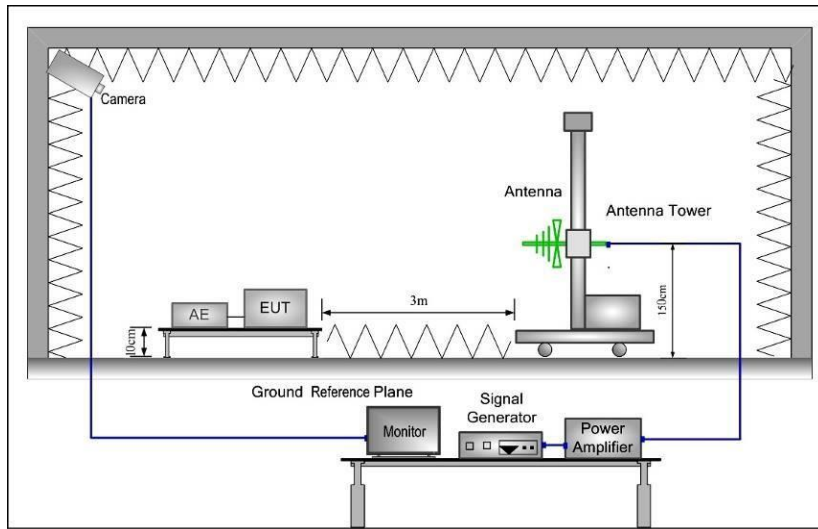

5.3.2 E.U.T. Operation

Operating Environment:
 Temperature: 25°C Humidity: 50% Rh Atmospheric Pressure: 1002Mbar
 Test mode :Normal Working_keep EUT normal running continua

5.3.3 Test Results:

Frequency	Level (V/m)	EUT Face	Dwell time	Result / Observations
80MHz-1GHz	10	Vertical	3s	A
80MHz-1GHz	10	Horizontal	3s	A

Results:

A: No degradation in the performance of the EUT was observed.

5.4 Electrical Fast Transients/Burst at Power Port

Test Requirement: EN IEC 61000-6-2:2019
 Test Method: EN 61000-4-4:2012
 Performance Criterion: B
 Repetition Frequency: 5kHz
 Burst Period: 300ms
 Test Duration: 2 minute per level & polarity

5.4.1 Test Setup Diagram

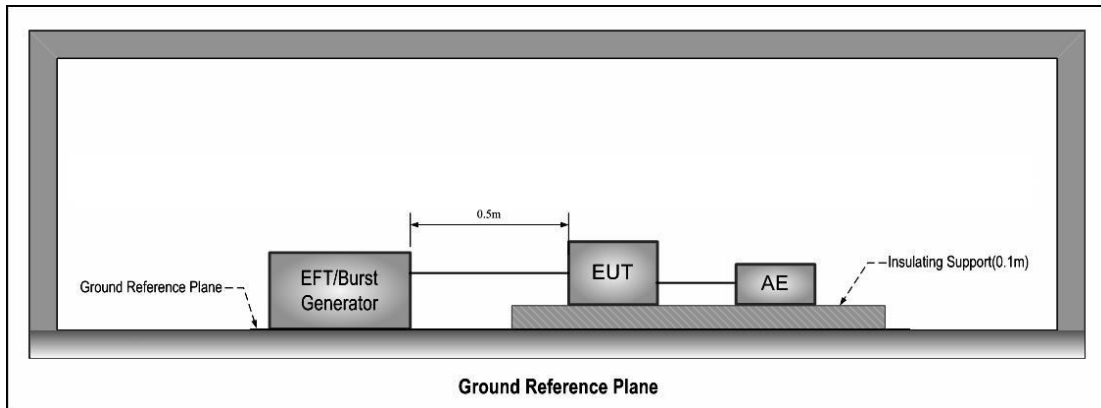

5.4.2 E.U.T. Operation

Operating Environment:
 Temperature: 25°C Humidity: 51% Rh Atmospheric Pressure: 1020Mbar
 Test mode :Normal Working_keep EUT normal running continua

5.4.3 Test Results:

Test Line	Level (kV)	Test Point	Result / Observations
AC power port	2	L	A
AC power port	2	N	A
AC power port	2	PE	A

Results:

A: No degradation in the performance of the EUT was observed.

5.5 Surge at Power Port

Test Requirement: EN IEC 61000-6-2:2019
 Test Method: EN 61000-4-5:2014+A1:2017
 Performance Criterion: B
 Interval: 60s between each surge
 No. of surges: 5 positive, 5 negative at 0°, 90°, 180°, 270°.

5.5.1 Test Setup Diagram

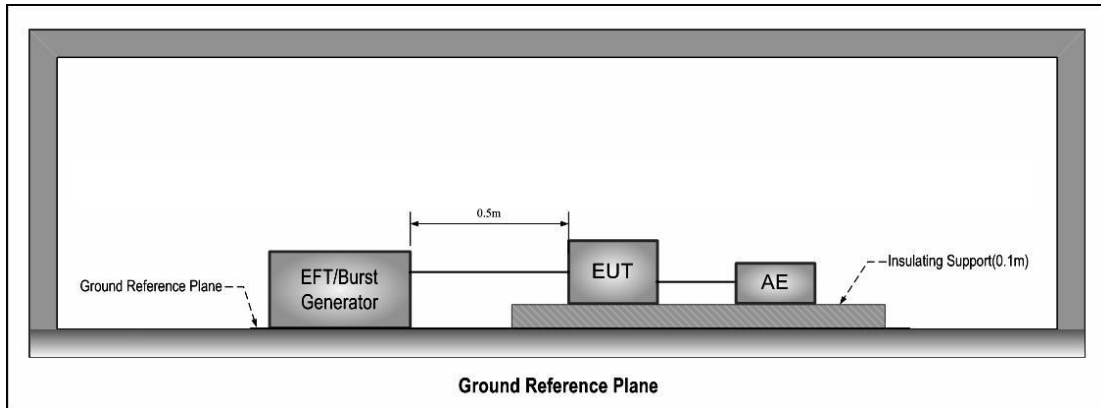

5.5.2 E.U.T. Operation

Operating Environment:
 Temperature: 25°C Humidity: 51% Rh Atmospheric Pressure: 1020Mbar
 Test mode :Normal Working_ keep EUT normal running continua

5.5.3 Test Results:

Test Line	Level (kV)	Polarity	Phase (deg)	Result / Observations
L-N	1	+/-	0°	A
L-N	1	+/-	90°	A
L-N	1	+/-	180°	A
L-N	1	+/-	270°	A
L-PE	2	+/-	0°	A
L-PE	2	+/-	90°	A
L-PE	2	+/-	180°	A
L-PE	2	+/-	270°	A
N-PE	2	+/-	0°	A
N-PE	2	+/-	90°	A
N-PE	2	+/-	180°	A
N-PE	2	+/-	270°	A

Results:

A: No degradation in the performance of the EUT was observed.

5.6 Conducted Immunity at Power Port (150kHz-80MHz)

Test Requirement: EN IEC 61000-6-2:2019
 Test Method: EN IEC 61000-4-6:2023
 Performance Criterion: A
 Frequency Range: 0.15MHz to 80MHz
 Modulation: 80%, 1kHz Amplitude Modulation
 Step Size: 1%

5.6.1 Test Setup Diagram

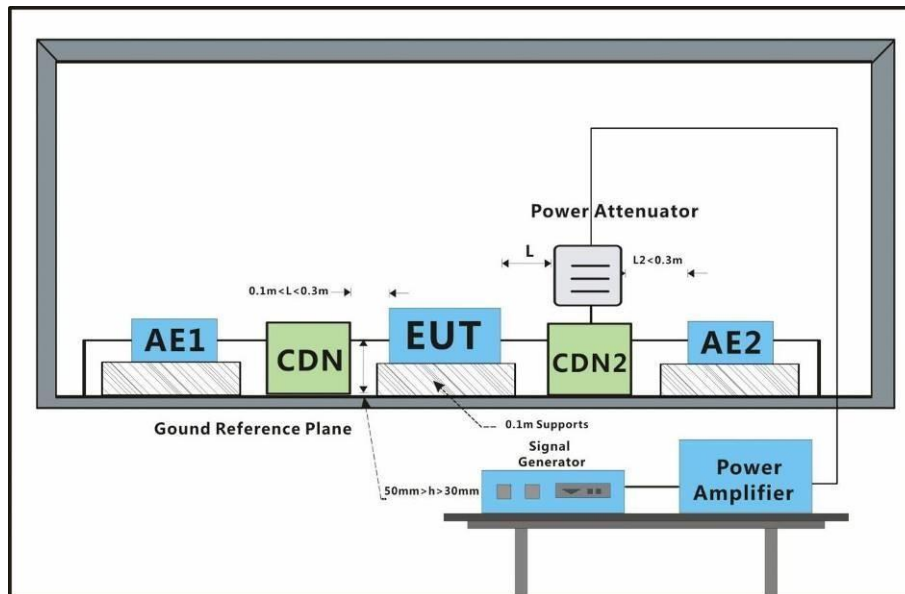

5.6.2 E.U.T. Operation

Operating Environment:
 Temperature: 25°C Humidity: 50% Rh Atmospheric Pressure: 1002 Mbar
 Test mode :Normal Working_keep EUT normal running continua

5.6.3 Test Results:

Cable port	Level (Vrms)	CDN/Clamp	Dwell time	Result / Observations
AC power port	10	CDN	3s	A

Results:

A: No degradation in the performance of the EUT was observed.

5.7 Power-Frequency Magnetic Field Immunity Test

5.7.1 Test Setup Diagram

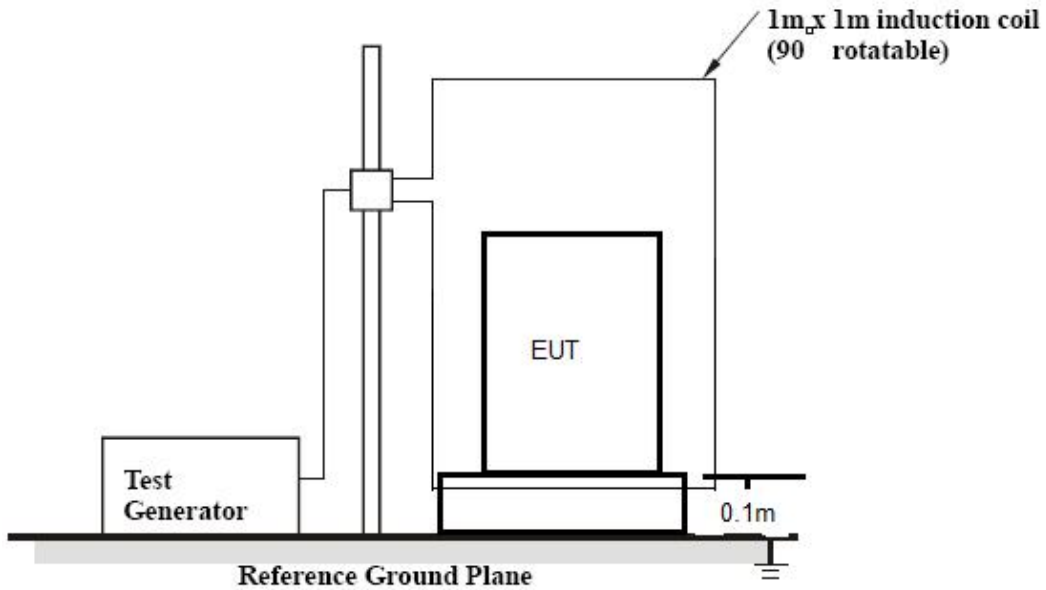

5.7.2 Applicable Standard

EN 61000-4-8:2010, Magnetic field strength: 30A/m

5.7.3 Severity Levels And Performance Criterion

Severity level:

Test Level	Magnetic field strength A/m
1	1
2	3
3	10
4	30
5	100
X	Special

Performance criterion: A

5.7.4 Test Results

Temperature: 25°C Humidity: 50% Rh Atmospheric Pressure: 1002 Mbar
 Test mode : Normal Working_keep EUT normal running continua

Test Level (A/m)	Testing Duration (in second)	Coil Orientation	Criterion
30	120	Axis-X	A
30	120	Axis-Y	A
30	120	Axis-Z	A

5.7.5 Test Conclusion

Pass

5.8 Voltage Dips And Short Interruptions Immunity Test

5.8.1 Test Setup Diagram

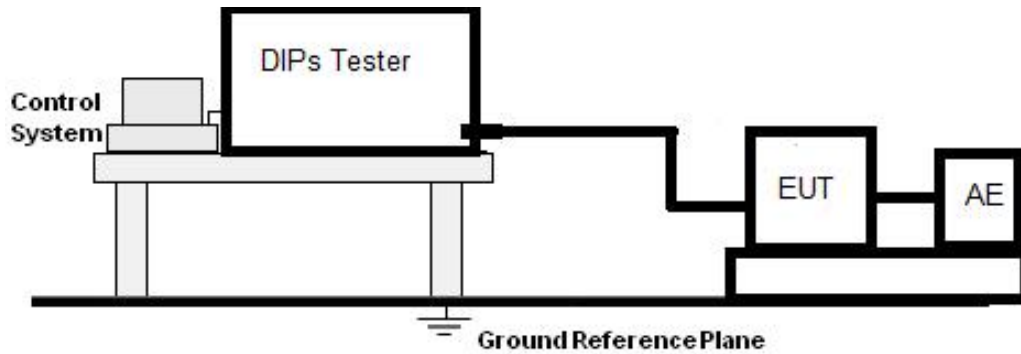

5.8.2 Applicable Standard

EN IEC 61000-4-11:2020, Test Value: Voltage dips: Dips 100% reduction: 1 cycle; Dips 60% reduction: 10 cycles; Dips 30% reduction: 25 cycles; Voltage interruptions 100% reduction: 250 cycles.

5.8.3 Severity Levels And Performance Criterion

Preferred severity levels and durations for voltage dips

Class ^a	Test level and durations for voltage dips (ts) (50Hz/60Hz)				
Class 1	Case-by-case according to the equipment requirements				
Class 2	0% during ½ cycle	0% during 1 cycle	70% during 25/30 ^c cycles		
Class 3	0% during ½ cycle	0% during 1 cycle	40% during 10/12 ^c cycles	70% during 25/30 ^c cycles	80% during 250/300 ^c cycles
Class X ^b	X	X	X	X	X

a Classes as per IEC 61000-2-4.

b To be defined by product committee. For equipment connected directly or indirectly to the public network, the levels must not be less severe than Class 2.

c “25/30 cycles” means “25 cycles for 50Hz Test” and “30 cycles for 60Hz Test”.

Preferred severity levels and durations for short interruptions:

Class ^a	Test level and durations for short interruptions (ts) (50Hz/60Hz)
Class 1	Case-by-case according to the equipment requirements
Class 2	0% during 250/300 ^c cycles
Class 3	80% during 250/300 ^c cycles
Class X ^b	X

- a Classes as per IEC 61000-2-4.
- b To be defined by product committee. For equipment connected directly or indirectly to the public network, the levels must not be less severe than Class 2.
- c “250/300 cycles” means “250 cycles for 50Hz Test” and “300 cycles for 60Hz Test”.

Performance criterion:

Voltage Dips 100%Reduction 1 cycle: B

Voltage Dips 60% Reduction 10 cycles: C

Voltage Dips 30% Reduction 25 period: C

Voltage interruptions 100% Reduction 250 period: C

5.8.4 Test Results

Temperature: 25°C Humidity: 50% Rh Atmospheric Pressure: 1002 Mbar
 Test mode : Normal Working_keep EUT normal running continua

Test level (%U _t)	Voltage Dips& Short Interruptions (%U _t)	Duration (cycle)	Phase (in angle)	Criterion	Voltage phenomenon
0	100	1	0°, 45°, 90°, 135°, 180°, 225°, 270°, 315°	A	Dips
40	60	10	0°, 45°, 90°, 135°, 180°, 225°, 270°, 315°	A	Dips
70	30	25	0°, 45°, 90°, 135°, 180°, 225°, 270°, 315°	A	Dips
0	100	250	0°, 45°, 90°, 135°, 180°, 225°, 270°, 315°	C	Interruptions

5.8.5 Test Conclusion

Pass

6. Harmonic Current Emission Test

6.1 Diagram Of Test Setup

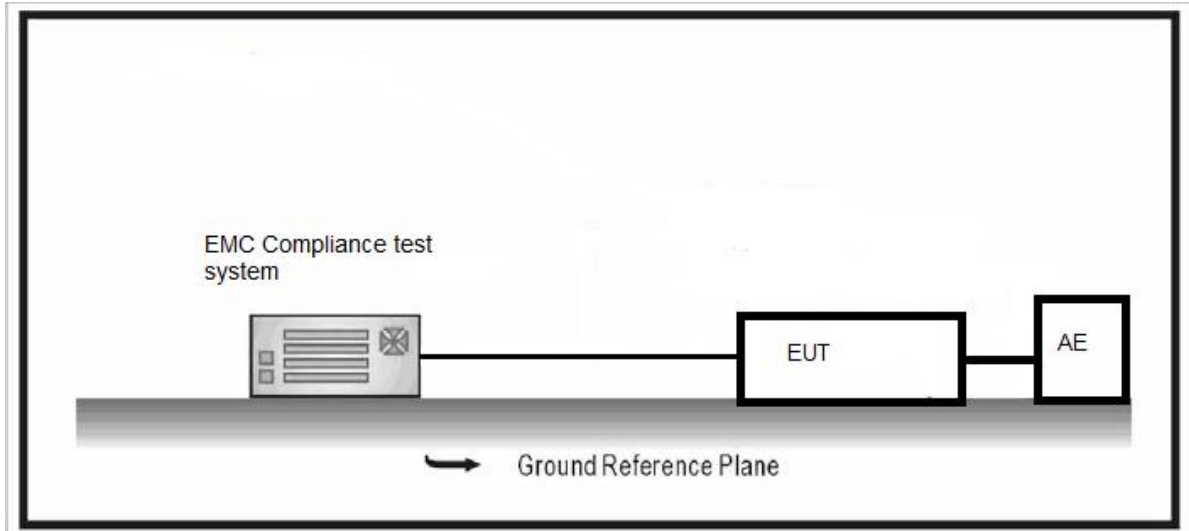

6.2 Applicable Standard

EN IEC 61000-3-2:2019+A1:2021 (CLASS A)

6.3 Harmonic Current Limits

Limits for Class A equipment	
Harmonics Order n	Max. permissible harmonics current A
Odd harmonics	
3	2.30
5	1.14
7	0.77
9	0.40
11	0.33
13	0.21
$15 \leq n \leq 39$	$0.15 \times 15/n$
Even harmonics	
2	1.08
4	0.43
6	0.30
$8 \leq n \leq 40$	$0.23 \times 8/n$

6.4 Test Results

Temperature: 25°C Humidity: 50% Rh Atmospheric Pressure: 1002 Mbar
 Test mode :Normal Working_keep EUT normal running continua

Harmonic	Status	Avg (A)	Avg L(A)	Avg %ofL	Peak (A)	Peak L(A)	Peak %ofL
1	PASS	0.36425	No Limit	N/A	0.3645	No Limit	N/A
2	PASS	0.0001	1.08	0.009559	0.00027	1.62	0.016873
3	PASS	0.34089	2.3	14.8213	0.34133	3.45	9.893623
4	PASS	0.00032	0.43	0.074881	0.00042	0.645	0.065122
5	PASS	0.30195	1.14	26.48684	0.30273	1.71	17.70351
6	PASS	0.00044	0.3	0.145803	0.00054	0.45	0.120938
7	PASS	0.25029	0.77	32.5052	0.25146	1.155	21.77143
8	PASS	0.00045	0.23	0.193478	0.00059	0.345	0.172043
9	PASS	0.19305	0.4	48.2625	0.19457	0.6	32.42833
10	PASS	0.00041	0.184	0.224772	0.00055	0.276	0.197909
11	PASS	0.1382	0.33	41.87879	0.13993	0.495	28.26869
12	PASS	0.00029	0.15333	0.191737	0.00043	0.23	0.185674
13	PASS	0.09452	0.21	45.00953	0.09627	0.315	30.56191
14	PASS	0.00012	0.13143	0.089021	0.00031	0.19715	0.155657
15	PASS	0.0698	0.15	46.53333	0.07125	0.225	31.66444
16	PASS	3.5E-05	0.115	0.03021	0.00022	0.1725	0.126864
17	PASS	0.06322	0.13235	47.76804	0.06431	0.19853	32.39391
18	PASS	5.6E-05	0.10222	0.054777	0.00025	0.15333	0.162871
19	PASS	0.0624	0.11842	52.69465	0.06344	0.17763	35.71469
20	PASS	0.00013	0.092	0.139196	0.0003	0.138	0.219123
21	PASS	0.05825	0.10714	54.36905	0.05945	0.16071	36.99459
22	PASS	0.00012	0.08364	0.138625	0.0003	0.12545	0.239753
23	PASS	0.04965	0.09783	50.75134	0.05102	0.14674	34.76785
24	PASS	3.5E-05	0.07667	0.04579	0.00027	0.115	0.231938
25	PASS	0.03949	0.09	43.88111	0.04087	0.135	30.27555
26	PASS	1.7E-05	0.07077	0.024071	0.00018	0.10615	0.167361
27	PASS	0.03199	0.08333	38.39055	0.03318	0.125	26.54171
28	PASS	9E-06	0.06571	0.01332	0.00015	0.09857	0.147153
29	PASS	0.02934	0.07759	37.81352	0.03022	0.11638	25.9686
30	PASS	9E-06	0.06133	0.014185	0.00015	0.092	0.164436
31	PASS	0.02915	0.07258	40.15652	0.02991	0.10887	27.47367
32	PASS	2.4E-05	0.0575	0.041275	0.00019	0.08625	0.215942
33	PASS	0.028	0.06818	41.07096	0.02884	0.10227	28.20099
34	PASS	2.3E-05	0.05412	0.043261	0.0002	0.08118	0.248038
35	PASS	0.02477	0.06429	38.53249	0.02573	0.09643	26.68492
36	PASS	0.00001	0.05111	0.01913	0.00011	0.07667	0.147861
37	PASS	0.02044	0.06081	33.61234	0.02141	0.09122	23.46834
38	PASS	7E-06	0.04842	0.013614	0.00011	0.07263	0.14396
39	PASS	0.01708	0.05769	29.60029	0.01785	0.08654	20.62678
40	PASS	5E-06	0.046	0.011391	8.2E-05	0.069	0.119319

6.5 Test Conclusion

Pass

7. Voltage Fluctuations And Flicker Test

7.1 Diagram Of Test Setup

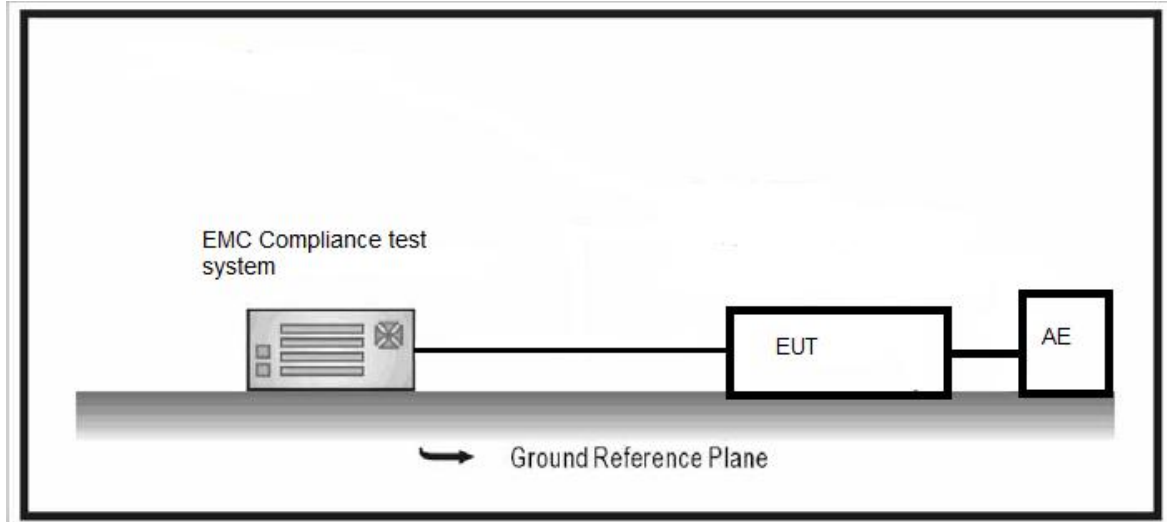

7.2 Applicable Standard EN 61000-3-3:2013+A1:2019+A2:2021

7.3 Voltage Fluctuations And Flicker Emission Limits

Test Item	Limit	Note
P_{st}	1.0	Short-term flicker indicator
P_{lt}	0.65	Long-term flicker indicator
$T_{dt}(ms)$	500	Maximum time that dt exceeds 3%
$d_{max}(\%)$	4%	Maximum relative voltage change
$d_c(\%)$	3.3%	Relative steady-state voltage change

7.4 Test Results

Temperature: 25°C Humidity: 50% Rh Atmospheric Pressure: 1002 Mbar
 Test mode :Normal Working_keep EUT normal running continua

Flicker Test Summary (Run time)

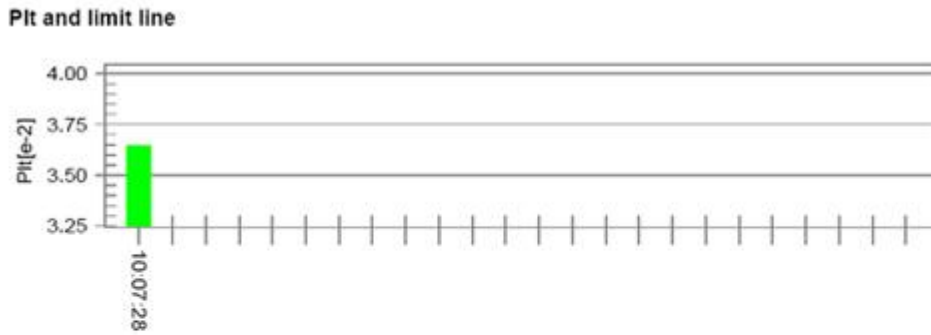
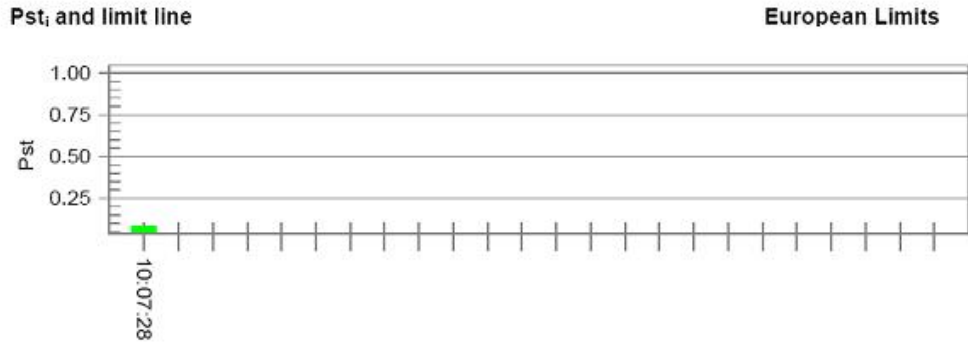

Parameter values recorded during the test:

Vrms at the end of test (Volt):	229.94		
Highest dt (%):	0.62	Test limit (%):	3.30 Pass
Time(mS) > dt:	0.0	Test limit (mS):	500.0 Pass
Highest dc (%):	0.00	Test limit (%):	3.30 Pass
Highest dmax (%):	-0.59	Test limit (%):	4.00 Pass
Highest Pst (10 min. period):	0.083	Test limit:	1.000 Pass

7.5 Test Conclusion

Pass

Photo documentation:

Type of equipment: Model:	Film Blowing Machine, CX600-3500, CX-B-700~CX-B-4000, CX-50-700, CX-55-900, CX-60-1100, CX-65-1300, CX-70-1600, CX-75-1800, CX-85-2200, CX-90-2400, CX-ABA-700~CX-ABA-2800, CX-ABC-900~CX-ABC-4000, CX- AB-700~CX- AB-4000
------------------------------	--

Details of:	
View: <input checked="" type="checkbox"/> general <input type="checkbox"/> front <input type="checkbox"/> rear <input type="checkbox"/> right <input type="checkbox"/> left <input type="checkbox"/> top <input type="checkbox"/> bottom	

Details of:	
View: <input checked="" type="checkbox"/> general <input type="checkbox"/> front <input type="checkbox"/> rear <input type="checkbox"/> right <input type="checkbox"/> left <input type="checkbox"/> top <input type="checkbox"/> bottom	

Details of:	
View: <input checked="" type="checkbox"/> general <input type="checkbox"/> front <input type="checkbox"/> rear <input type="checkbox"/> right <input type="checkbox"/> left <input type="checkbox"/> top <input type="checkbox"/> bottom	

Details of:	
View: <input checked="" type="checkbox"/> general <input type="checkbox"/> front <input type="checkbox"/> rear <input type="checkbox"/> right <input type="checkbox"/> left <input type="checkbox"/> top <input type="checkbox"/> bottom	